

OWNER MANUAL

Rev. 01 | Ed. 01 | 04/2024
Cod. X5044061



BAGGER



CALIBRO



CALIBRO

VEHICLE DESIGNED IN ITALY, PRODUCED AND ASSEMBLED IN CHINA

Dear Customer,

- *Congratulations on your excellent choice.*
- *Your new motorcycle is the result of the strictest tests and it represents the most up-to-date display of technology in this field.*
- *A trouble-free operation of the motorcycle through time depends on the use it will be subjected to and on appropriate maintenance. For this reason, we strongly suggest you conform to the information stated in this booklet, which must be carefully read before operating the motorcycle and will have to be consulted any time there is even the smallest doubt. In case you should lend your motorcycle (we strongly discourage doing so) to a friend, make sure they have read the paragraphs concerning riding safety and use of the motorcycle itself.*
- *For servicing, extraordinary maintenance, spare parts and accessories always and exclusively refer to Moto Morini authorized Service Centers.*
- *This manual must be preserved for the whole life of the motorcycle and in case of transfer of title it will have to be handed over to the new owner.*
- *All information reported in this manual is up-to-date as of printing date.*
- *Moto Morini reserves the right to apply all changes required by the evolution and development of its motorcycles without notice obligation.*

Always abide by the traffic laws, ride carefully and... Have a good journey!

Accompanying documentation of the motorcycle

- User Manual
(Including Warranty booklet).

Motorcycle identification data

A = VIN ZLM100102...

B = homologation tag

NOTE

Falsification of identification data is punishable by law. Do not remove the tag (B) reporting homologation data.



Accompanying documentation of the motorcycle ...	2	Left-Head side (STR)	20
Motorcycle identification data	2	Right-hand side (STR)	21
Consultation Notes	5	General Information (SCR)	22
Symbols	5	Main component location (front)	22
Basic rules	6	Left-Head side (SCR)	23
Clothing	10	Right-hand side (SCR)	24
Riding with a passenger	10	Supplied equipment	25
Accessories	11	Provided keys	26
Load (Baggage)	12	Ignition Switch	27
Technical features	13	Fuel Tank Cap	28
Engine	13	Saddle	29
Timing system	13	Saddle removal.....	29
Fuel system	13	Saddle assembly	29
Exhaust system	13	Dashboard	30
Valve clearance	14	Indicator light (Specific function)	31
Lubrication	14	Basic information of vertical menu	34
Cooling system	14	Disconnecting a device	38
Transmission	15	Basic information of horizontal menu	46
Homologation	16	Basic information of display function	47
Overall dimensions	17	Basic information of warning function	52
Electrical System	18	Clutch lever	55
Fluids/Lubricants	18	Distance adjustment	55
General Information (STR)	19	Front Brake lever	56
Main component location (anteriore)	19	Distance adjustment	56
		Check of the clutch cable	57

Front fork	58	Transmission Chain	96
Adjustment of compression	59	Electrical components	97
Rear shock absorber	60	Fuses	97
Rebound adjustment	61	Ignition coils diagnostics sockets	99
Gear shifting lever	62	Battery	100
Start	62	Battery Maintenance	100
Gear shift:	62	Remove the battery	101
Position adjustment	63	Re-Install the battery	102
Rear Brake Pedal (1)	64	Headlamp	103
Side Stand	65	Indicator lights	104
Tires	66	License plate light	104
Fuel Tank	68	Tail light	104
Refueling	68		
Terms of use	69		
Run-in (1000 km)	70		
Check items before use	71		
Riding skills	72		
Safety precautions for the first use of motorcycles	73		
Maintenance	83		
Daily maintenance	88		
Engine oil	89		
Brake fluid	91		
Liquid level check	92		
Coolant	93		
Brake pads	95		

Consultation Notes

Symbols

- Symbols highlighting situations of maximum attention, practical advice or information have been used in order to ensure a quick and practical reading.
- Said symbols can be located next to a text (thus referring to that text only) next to a picture (referring to the subject of the picture and its text) or at the top of the page (referring to all topics treated in the page itself).

NOTE

Pay attention to the meaning of the symbols: their purpose is to avoid repetition of technical concepts or safety warnings.

NOTE

Some pictures could differ from the motorcycle in use.

SYMBOL	DESCRIPTION
	WARNING! Dangerous situations with grievous bodily harm or even death.
	IMPORTANT Possibility of damage to the motorcycle or parts of it.
	NOTE Topic of specific importance.
	INTERVENTIONS Interventions pertaining to the Authorized Service Centre.
	OPERATIONS Operations to carry out with the engine off.

Basic rules

- It is necessary to have all the requirements provided for by law in order to ride the motorcycle: minimum age, psychophysical eligibility, etc. in addition to the country-specific required documentation: driving license, registration, road tax, insurance, number plate etc..
- Good psychophysical conditions are essential for safety while riding the motorcycle. Drugs, alcohol abuse, psychotropic drugs etc., in addition to physical weariness and sleepiness can cause very dangerous situations.
- It is advised to use a helmet, in compliance with the current regulations in the reference country.
- It is advised to use all protective devices, reinforced jacket, boots and gloves.
- It is advised to become familiar with the motorcycle by initially riding it in low-traffic areas.
- A good percentage of motorcycle accidents are caused by the rider's inexperience.
- Never lend the motorcycle to beginners or inexperienced riders.
- Ride in a seated position, both hands firmly placed on the handlebar and feet correctly placed on the footrests. Avoid standing up and stretching out the legs while riding. In case of numbness of the limbs on long-distance routes, do not hesitate to stop in specific rest areas and do some simple exercise to restore blood flow and tone up the muscles. Never ride in a state of physical weariness or drowsiness.
- Rigorously abide by signage and national/local rules.
- Keep a safe distance from other vehicles when riding in a straight line.
- Always ride with the low beam switched on, even in daylight.
- Avoid abrupt and potentially dangerous moves.
- Adjust your riding style according to road surface.

- Adjust your riding style according to the additional load carried on the motorcycle, especially in presence of a passenger.
- It is forbidden to challenge other vehicles' drivers on public roads.
- Avoid riding the motorcycle off-road as much as possible.
- When the road is wet or slippery, ride with maximum concentration. Use the brakes gently and mainly use the engine brake.
- Always ride so to be very visible in every condition. Do not ride in the “blind spots” of the vehicles in front of you.
- Pay extreme attention at crossroads that have no traffic lights, when close to an access to private areas or public parking areas, in entry lanes to ring roads or motorways.
- When refueling the motorcycle, always switch the engine off. Do not smoke when performing the aforementioned operation.
- Remove the ignition key during stops (even short ones) if the motorcycle is left unattended.
- Park the motorcycle so that it cannot be bumped into, especially by pedestrians as the engine, the exhaust pipes and the silencer maintain a high temperature for a long time.
- Never park on rough or soft terrains or asphalt that has been softened by sunlight.
- Changes of direction or lane, side street turns, pull overs for parking or stopping must always be signaled well in advance by using the direction indicators.
- Whenever close to crossroads, stops, traffic lights, level crossings, holes, ditches, speed bumps and any other perceivable obstacle, slow down in time with moderation.
- When the engine is switched off and the ignition key is positioned to “ON”, the low beam switches off

after a few seconds.

- Before every trip, always check: tire wear and pressure, efficiency of the lighting and braking systems, engine oil and coolant levels.
- Only use the products recommended by Moto Morini. In case of any top-ups, avoid mixing different, incompatible oils with one another.
- Do not ride with the helmet hanging off your arm or off the handlebar, even for short commutes. The helmet must be worn during every motorcycle ride (this applies to the passenger as well).
- Never distract oneself or get distracted while riding.
- Do not use mobile or audio devices while riding.
- Do not use earphones, only use appropriately homologated devices for these purposes.
- Alterations and tampering (even minor ones) exempt the manufacturer from any responsibility regarding any kind of damage and cause the termination of the warranty rights

**WARNING!**

Do not ride in the stream of the vehicles ahead.

Do not ride paired up to other riders.

Do not tow or get towed by other vehicles.

Do not sit on the motorcycle while it is parked on the kickstand.

Do not put the motorcycle on the kickstand when the travel direction goes downhill.

Do not start the engine in indoor spaces.

Do not ride on pedestrians' walks, under covered walks, on public park lawns, etc.

Do not keep pointy or fragile objects in your pockets while riding.

Do not ride in case of adverse weather conditions (temperatures close to 0° C, ice, snow, heavy rain, etc.).

Clothing

- Appropriate clothing consists of protective garments in light or refractive colors in order to always be perfectly visible even in poor visibility conditions. Avoid any loose-hanging tails, unbuttoned jackets, excessively heavy or tight gloves and inappropriate shoes.

Riding with a passenger

- Carrying a passenger on the seat influences the riding to a great extent. The weight has a direct effect on the tires, whose pressure will need to be increased and on the rear shock absorber, that will have to be calibrated properly. The braking distance is considerably longer and bends have to be taken at a wider range, with a reduced lean angle and measured throttle opening. A higher degree of caution is also mandatory.
- Both rider and passenger must necessarily wear homologated, properly tied up helmets. The helmet must be properly sized, intact and with a perfectly clean visor.
- Briefly instruct the passenger on the behavior they will have to adopt before every trip (even short ones): do not make any abrupt move during the ride, do not place the feet on the ground during short rests such as stop signs or traffic light stops, do not look over the sides during the ride to look ahead, do not turn the head backwards and, above all, do not counterbalance the curve preparation set by the rider.
- Clear display of passenger anxiety must necessarily lead to highly cautious and careful driving.

**WARNING!**

Do not carry elderly or disabled people, children or animals.

Do not carry children on the motorcycle tank.

Accessories

- Moto Morini shall not be liable for any kind of damage resulting from the use of unexpected, non-homologated or in any way incompatible accessories according to the structural features of the motorcycle or accessories that have not been installed following the technical specifications of said accessory's manufacturer or Moto Morini or accessories that are not officially approved by Moto Morini's technical department (example: windscreen, luggage rack, top case, side panniers or bags, fairings, additional lights, etc.).
- The motorcycle user is responsible for the choice, set-up and practical use of the accessories. During set-up, it is important to verify that the visual and acoustic indication devices are not covered, the suspension travel and steering angle are not limited, the use of control devices is not hindered and ground clearance and leaning angle are not reduced.
- Always check that the accessories are properly attached to the motorcycle, especially in view of long journeys.
- Any accessory that modifies side and/or frontal clearances can cause vehicle imbalance, even if it is an original Moto Morini accessory. In these cases, it is advised not to exceed a 130 Km/h speed even if allowed.

NOTE

Always use original Moto Morini Accessories set up by the authorized Service Centre.

Load (Baggage)

- Baggage must be loaded so that its total weight is equally distributed on both sides of the vehicle, as close to its barycenter as possible. Baggage must be securely attached to the vehicle and it is good practice to check its correct anchoring during stops. A poorly anchored bag can make the motorcycle unsteady and cause extremely dangerous situations.



WARNING!

Do not position bulky baggage at the sides of the motorcycle; it could hit obstacles or people, causing a loss of control of the motorcycle itself.

Do not fasten any type of object to the handlebar.

Do not fasten any type of object to the front mudguard or close to the fork. This causes poor handling and hinders the regular air flow to the radiator, thus increasing the dangerous risk of the engine overheating.

Do not carry baggage or various types of objects sticking excessively out of the luggage rack or covering the lighting and signaling devices.

Do not exceed the maximum weight limit of the luggage rack. Overload is always a dangerous element while riding a motorcycle.

Do not exceed the load on the tank, especially height-wise.

Technical features

Engine

Twin-cylinder	4-stroke, DOHC
Total displacement	693 cc
Bore by stroke	83 x 64 mm
Compression ratio	11.6:1
Power	50.8 kW - 8.500 rpm
Engine torque	68 Nm a 6500 rpm
Power A2 vehicles	35 kW - 9.000 rpm
Engine torque A2 vehicles	43.5 Nm a 6000 rpm

Timing system

Double camshaft (Hydraulic tensioner)

Fuel system

Electronic fuel injection



Ø40mm throttle body.

Exhaust system

Silencer, catalyst and 2 LAMBDA sensors.

Valve clearance

Intake.....	0.08-0.13mm
Exhaust.....	0.2-0.26 mm

Lubrication

Oil:	Power Synt 10W40
Capacity*: draining	2.6L
with filter replacement.....	2.2L
without filter replacement.....	2L

Cooling system

Liquid.

Thermostat starts opening:.....	87-97°C
---------------------------------	---------

Transmission

- 6-Speed gearbox.
- Final drive 15/46
- Gear ratio: Beginning - (2.095), **1st**-2.353, **2nd**-1.714, **3rd**-1.333, **4th**-1.111, **5th**-0.966, **6th**-0.852.
- Primary drive: spur gears.
- Final drive: belt.
- Clutch: multi-disks wet type.

Homologation

Euro 5 vehicle

- Frame: steel tube structure
Swing-arm: Aluminum die-casting
Wheelbase: 1490 mm - Rake angle: 28° Track: 122mm- Steering angle: 38°
- Front suspension: adjustable inverted fork Ø41mm.–Stroke: 130mm
- Front wheel (standard): A356 aluminum wheel — 3,50x18" – tire: 130/70-R18"
- Rear suspension: adjustable monoshock: adjustable twin shock absorbers (stroke 70 mm)
- Rear wheel (standard configuration): A356 aluminum wheel — 5.000x16" – tire: 180/65-R16"
- Brake front: Single disc Ø320mm. Caliper with 2 pistons and 2 brake pads.
- Brake rear: Single disc Ø255mm. Caliper with 1 piston and 2 brake pads.
- Fuel tank capacity: 16 l.
- Dry weight: 204 kg

Overall dimensions

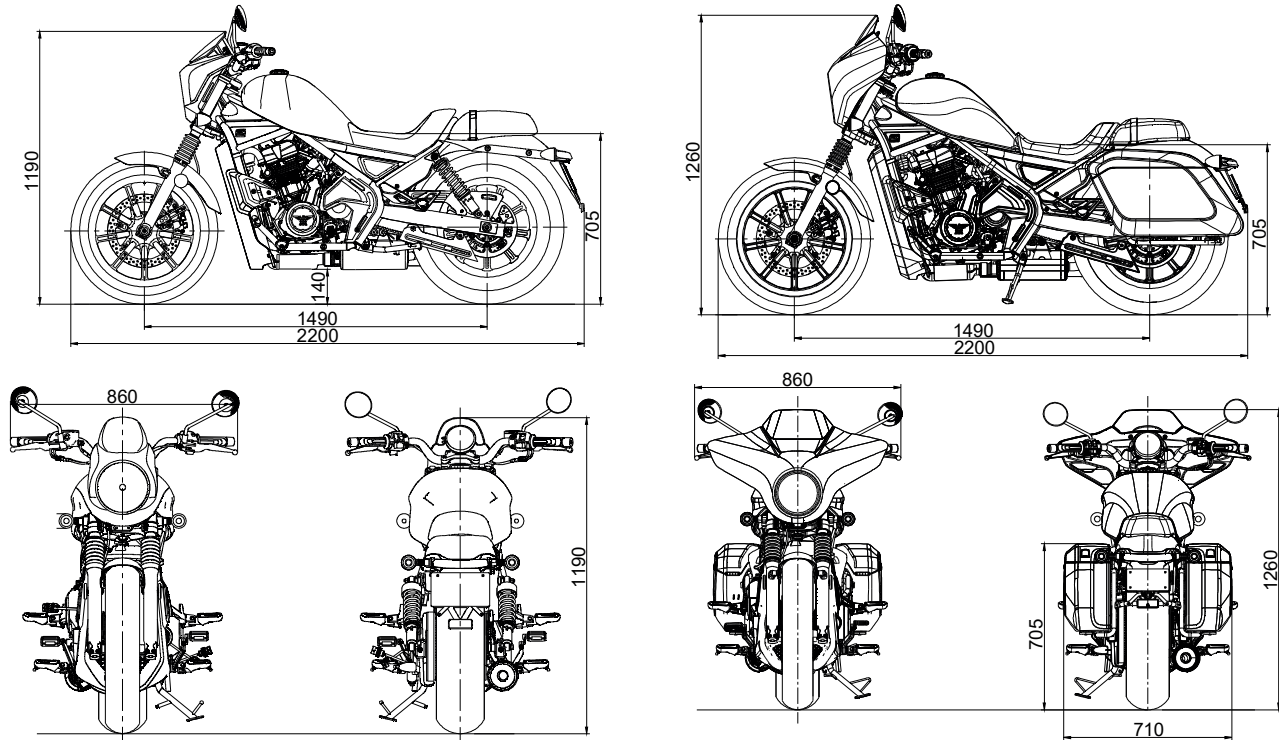

Electrical System

- Battery: 12V - 11,2Ah
- Instrumentation: LCD Display.
- Spark plugs: CR8EI

Fluids/Lubricants

- Fuel: leaded petrol R.O.N. 95
- Coolant: COOLANT G40
- Engine oil: 10W40-SN 
- Brake and clutch fluid: BRAKE FLUID DOT 4 

General Information (CALIBRO)

Main component location (anteriore)

No.	Instruction
1	Rearview mirror
2	Left handgrip
3	Clutch lever
4	Left handle switch
5	Handlebar fixing
6	Right handle switch
7	Throttle
8	Front brake lever
9	Front brake fluid tank
10	Dashboard

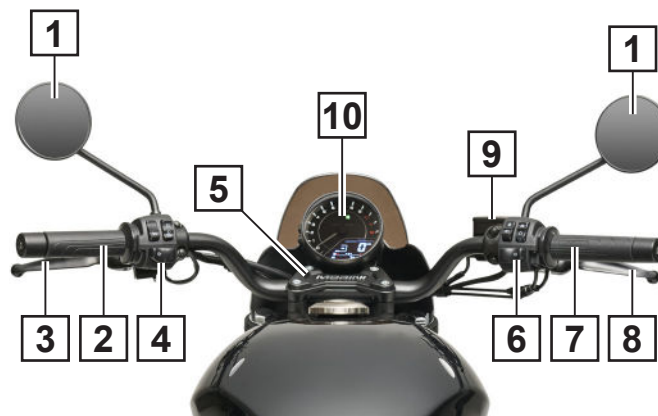

Left-Head side (CALIBRO)

No.	Instruction
1	Rear shock absorber
2	Radiator-engine coolant
3	Rear light / license plate light
4	Shift lever
5	Side stand
6	Left footplate
7	Drive belt
8	Saddle
9	Fuel tank
10	Passenger saddle
11	Rear indicator lights



Right-hand side (CALIBRO)

No.	Instruction
1	Rear brake caliper
2	Right footplate
3	Rear brake lever
4	Rear indicator lights
5	Front brake caliper
6	Front light
7	Fuel tank cap
8	Rear brake fluid reservoir
9	Silencer
10	Front forks
11	Ignition key
12	Coolant liquid expansion tank

No.	Instruction
13	Steering lock



General Information (BAGGER)

Main component location (front)

No.	Instruction
1	Rearview mirror
2	Left handgrip
3	Clutch lever
4	Left handle switch
5	Handlebar fixing
6	Right handle switch
7	Throttle
8	Front brake lever
9	Front brake fluid tank
10	Dashboard

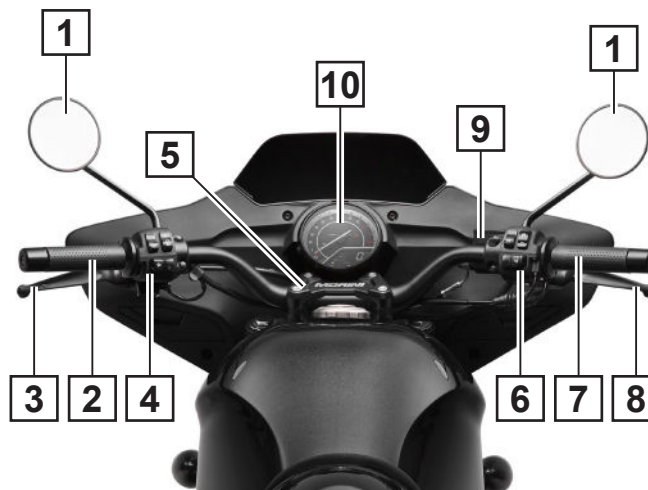

Left-Head side (BAGGER)

No.	Instruction
1	Left lateral bag
2	Radiator-engine coolant
3	Rear light / license plate light
4	Shift lever
5	Side stand
6	Left footplate
7	Drive belt
8	Saddle
9	Fuel tank
10	Passenger saddle
11	Rear indicator lights
12	Rear shock absorber

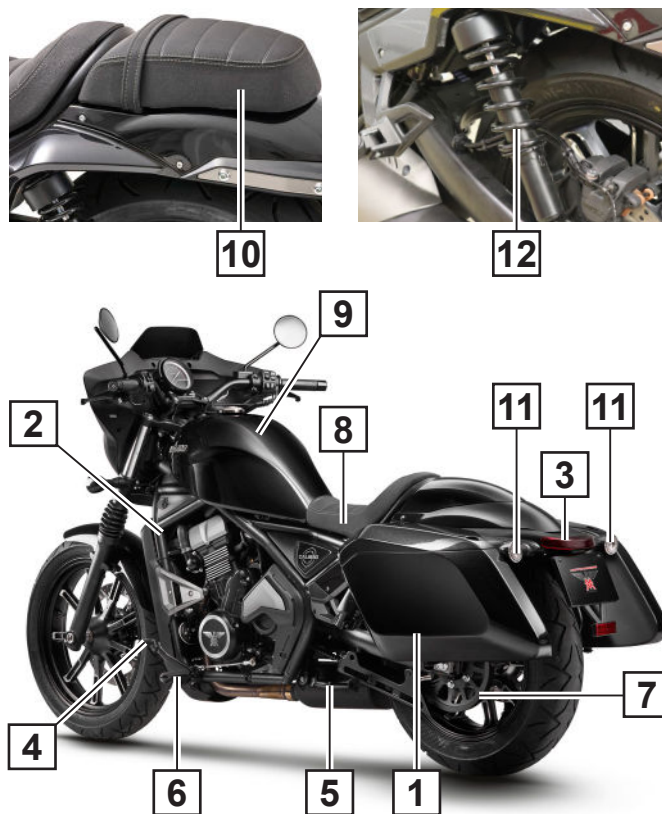

Right-hand side (SCR)

No.	Instruction
1	Right lateral bag
2	Right footplate
3	Rear brake lever
4	Front indicator lights
5	Right front brake caliper
6	Front light
7	Fuel tank cap
8	Rear brake fluid reservoir
9	Silencer
10	Front forks
11	Ignition key
12	Coolant liquid expansion tank

No.	Instruction
13	Front windscreen
14	Steering lock

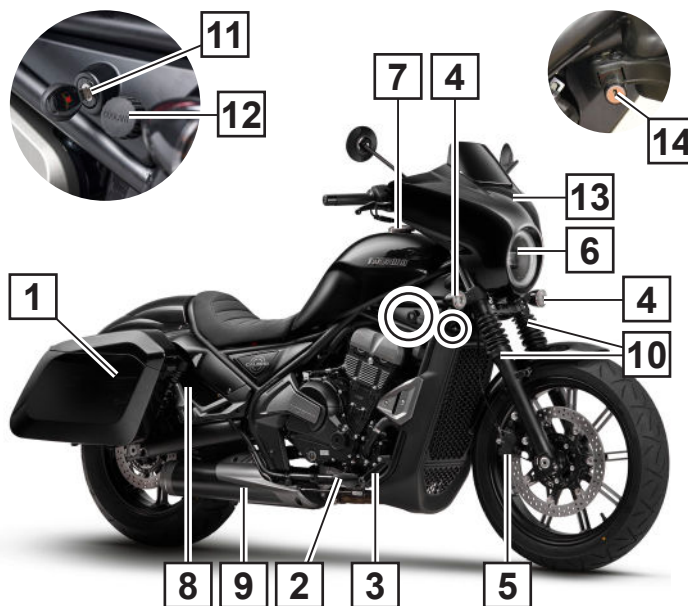

Supplied equipment

The vehicle comes with on-board tools:

- Allen wrench (1): Allen wrench.
- Replaceable screwdriver (1): flat head- cross head.
- Wrench (2): size 8-10; size 14-17.

The vehicle tool is located under the passenger seat

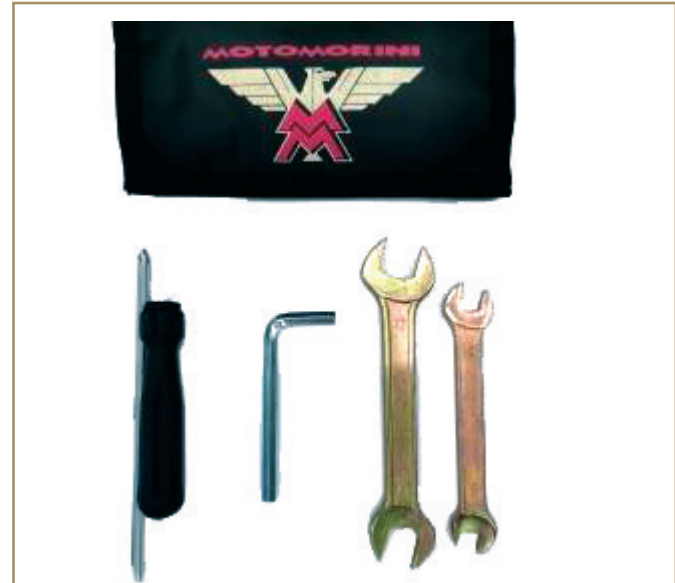

Provided keys

- The motorcycle is delivered with 2 pcs of identical keys.

NOTE

- Separate the two keys and store one of them in a safe place.
- It is recommended to save the key picture for copy after loss(the picture is real key).



IMPORTANT

It is advised to use a keyring made out of soft material that will not mark the exterior of the motorcycle.

NOTE

- In case of a key loss, report it as lost and, if necessary, head to the Service Centre for locks replacement.

Ignition Switch

- The three-position switch is on the right side of the vehicle.
- The positions can be activated through the key.

Location instruction:

A. No power, the circuit is disconnected;

B. Ignition powered: all the electric equipment is operational.

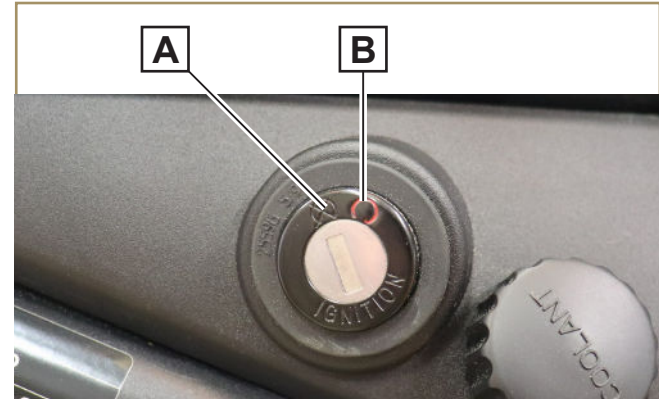

NOTE

To avoid discharging the battery, start the engine as soon as possible after turning the ignition key to “↻” position; if it is left in “↻” position for a long period of time, the battery may discharge:



IMPORTANT

The key can be extracted only when it is rotated to switching off ~~↻~~.

Once inserted, the ignition key can be rotated and moved between the various modes.

Fuel Tank Cap

Opening

Before opening the fuel tank cap, move the lock guard (1); insert the ignition key (2) into the fuel tank cap (3), push it into place, turn the key clockwise to release the lock block and remove the cap (3);

NOTE

The key (2) remains attached to the cap (3).

Closing

To close the fuel tank cap (3), align the notch (4) with the hollow (5) on the tank; push the cap (3) until a "click" sound is heard; the key (2) turns to the extraction position.

Extract the key and turn the lock guard (1).

NOTE

Check the cap is closed correctly after each refuelling.

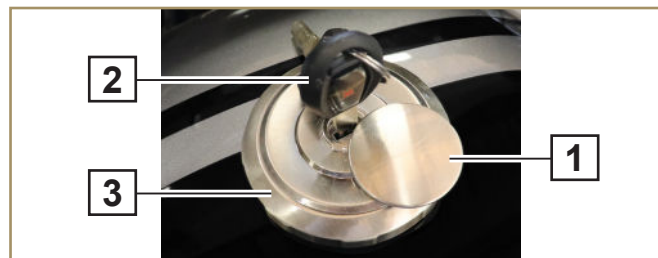

Steering lock

The motorcycle has a steering lock (1) positioned on the right side of the steering column.

Operate as follows to lock steering:

- turn the handlebar to the left, insert the key into the lock and turn it anti-clockwise. Push the key inwards, turn the key clockwise and then extract it from the lock.

NOTE

If necessary, turn the handlebar slightly in both directions to promote rotation of the key.

- Operate in reverse order to release steering.



IMPORTANT

Do not turn the handlebar with the key inserted in the steering lock in order to prevent it from breaking.

Saddle

Removal and re-assembly of the rider's saddle

- Slightly lift the rear part of the saddle (1), loosen the two screws (2) and remove the saddle (1) by lifting the rear part slightly and moving it towards the rear of the motorcycle "A";
- To re-assemble the saddle (1) insert the hook (3) into the housing (4) of the chassis and push the saddle towards the tank "B", checking that the front part of the saddle is inserted into the relevant hook correctly.
- Tighten the screws (2).

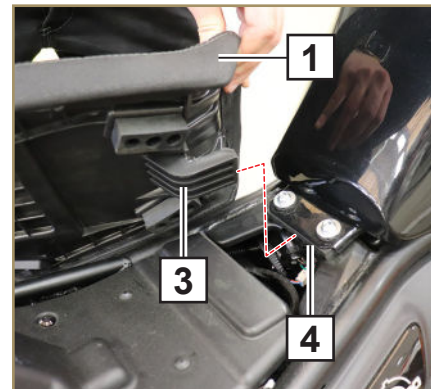

Removal and re-assembly of the passenger's saddle

- Remove the rider's saddle as described in the relative paragraph.
- Loosen the screw (5); remove the passenger's saddle (6) by moving it towards the rear of the motorcycle "C";
- To re-assemble the saddle (6), insert the hooks (7) and (8) into the respective housings (9) and (10) pushing the saddle (6) towards the tank "D", checking that the hooks are inserted correctly.
- Tighten the screw (5).

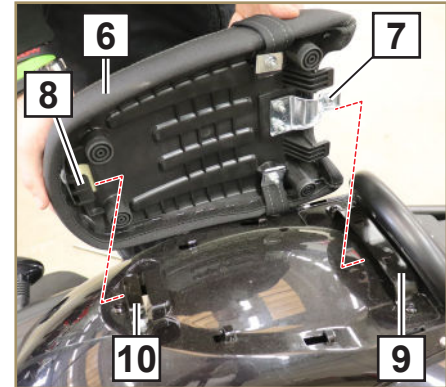
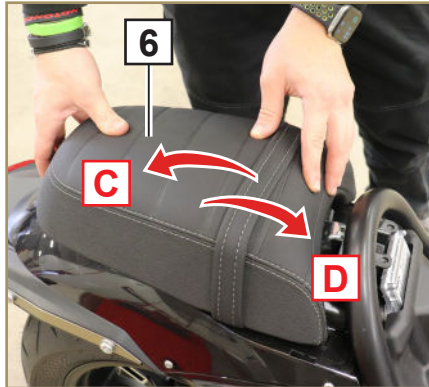
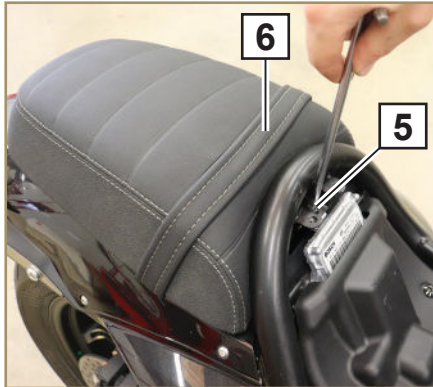

Dashboard





No.	Instruction
1	Luminous indicators
2	Rev. counter
3	Gear indicator
4	Speedometer
5	Fuel level indicator
6	Coolant liquid temperature
7	Total/partial kilometres





NOTE

By rotating the key into the ignition block to “” position, all the indicators follow a self-test before start-up of the engine.



Indicator light (Specific function)

Warning light	Description	State	Instruction
	Engine anomaly LED (yellow)	Turn on	Turn on the ignition switch , the icon should be lit up,
		Flashing	Indicates that the DFI system is malfunctioning. Go to an authorised Moto Morini dealer for a check.
	ABS indicator light (yellow)	Off	Activate the ignition switch: after the self-check, the LED will switch off when the speed reaches or exceeds 5 km/h (3.1 mph). The ABS LED switches off, indicating that the ABS system is operating normally.
		Turned on or Flashing	The ABS is malfunctioning. Except for the traditional brake function, ABS does not work. Ask an authorized Moto Morini dealer to check the ABS.
	Left turn indicator (green)	/	When the direction indicator lever is moved to the left, the left turn indicator LED flashes.
	Daytime light indicator (green)	/	When the daytime running light is on, the signaling indicator is on.

Warning light	Description	State	Instruction
	Neutral indicator (green)	/	When the transmission is in neutral, the indicator light is on.
	High beam indicator (blue)	/	When the front light is in the high beam, the indicator light is on.
	Right turn indicator (green)	/	When the direction indicator lever is moved to the right, the right turn indicator LED flashes.
	Engine oil pressure LED (red)	Turn on	With dashboard on and engine off, the indicator is lighted up. On starting the engine, the LED switches off. If the indicator remains on when the engine speed is at a value equal or higher than idling speed, immediately stop the engine and check engine oil. If the amount of oil is insufficient, add oil. If the amount of oil is sufficient, please check the engine with an authorized Moto Morini dealer.
	Coolant liquid temperature alarm LED (red)	/	The LED switches on when the temperature of the coolant liquid is $\geq 117^{\circ}$.

NOTE



The ABS indicator (yellow) remains on in the following cases:

1. At the start-up of the engine with side stand raised, the rear wheel rotating and the front wheel still;
2. When the motorcycle is exposed to strong electrical interferences;
3. If this happens, please turn off the ignition-switch first, then turn it on again, and drive the motorcycle at a speed of 5km/h (3.1mph) or higher.

The ABS indicator light should go out. If not, please go to an authorized Moto Morini dealer to check the ABS.

Use buttons (1) and (2) to enter the menu:

Button (1)

Short press

Display switches from total km/mi to partial km/mi (trip)

Button (2)

Short press

Changes from km to mi and vice versa

Long press

Partial km/mi (trip) reset

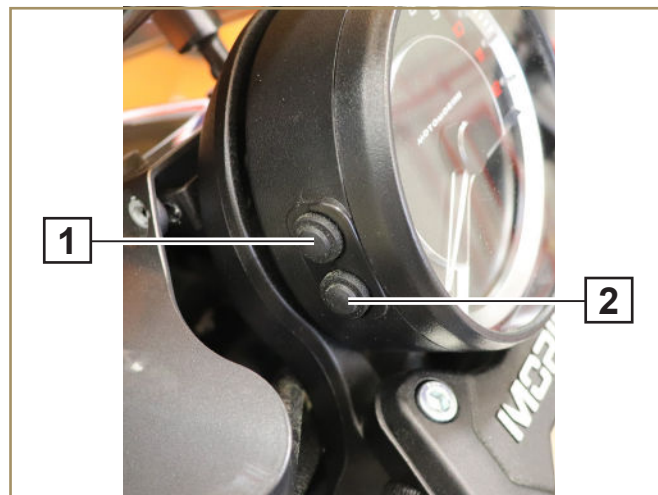

Instrument operation

Gear indicator (1):

Real time display of the gear engaged, from 1 to 6. When the gear is in neutral, "N" is indicated and the "N" LED is on.

Total km/mi ODO (2):

Displays the total distance travelled by the vehicle. The display range is 0-999999 km (620999 mi). When the total kilometres travelled reaches 999999 km, the display resets.

Speedometer (3):

Indicates the real travel speed expressed in km/h or mi/h, according to the scale set.

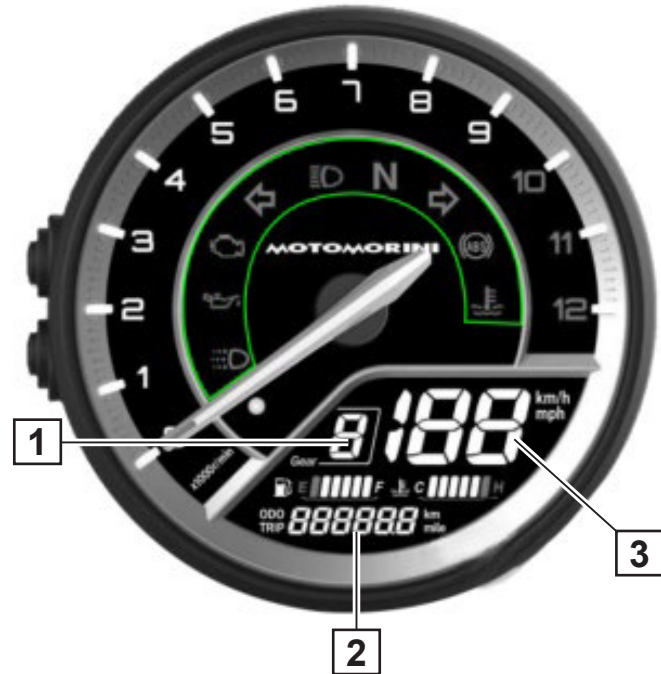

Rev. counter (4):

On rotating, the pointer (5) indicates the engine revs. per minute (RPM). When the number of revs. exceeds 9000 rpm, the pointer (5) enters the red zone (6).

NOTE

Avoid reaching the red area of the overspeed. Running in the red zone will overload the engine and may cause serious damage to the engine.



Fuel gauge (7):

The amount of fuel is indicated by six segments. When the last segment is reached, it turns red and flashes. When the fuel gauge has no display segment, the remaining fuel available is about 2.0L. Please refuel as soon as possible.

If the fuel level indicator is faulty, the segments are displayed in red.

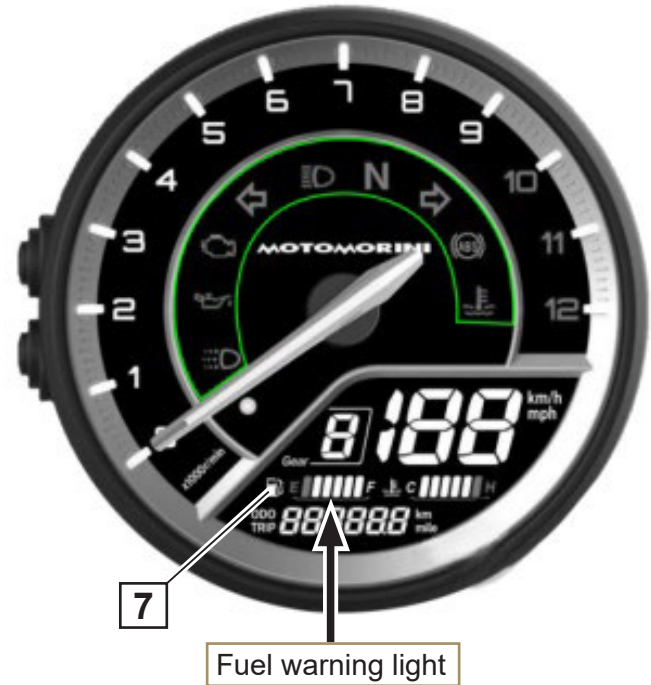

Coolant liquid temperature indicator (8):

It displays the real temperature of the engine coolant liquid. Every time the temperature reaches a determined value, this is shown in the relevant segment of the display (see the figure below). When the coolant liquid temperature rises to a value between 110°C (230°F) and 117°C (242.6°F), the notch turns red and the  LED lights up in red to warn the rider that the normal temperature value has been exceeded.

At this time, the engine needs to be turned off.

After the engine has cooled down, check the coolant level in the storage tank and check whether the cooling system is faulty. For detailed information about the coolant, please refer to the vehicle information in the setup menu.



Left-hand switch

1. "Overtaking(passing) lights" button

The headlight high beam sends a signal to the driver ahead to warn that the vehicle is about to pass; Release the button and the signal light will be turned off;

2. Horn button

Press the button to sound the horn.

3. Left turn direction indicator button

- Press the button on the left to activate the left turn indicator lights.
- Press the button on the right to deactivate the indicator lights.

4. High beam switch

- Operation of the high beam button is enabled when the low beam lights are switched on.
- Press the button to switch the high beam lights on, the LED (☰D) on the instrument lights up.
- To switch the high beam lights off, press the lower part of the button.

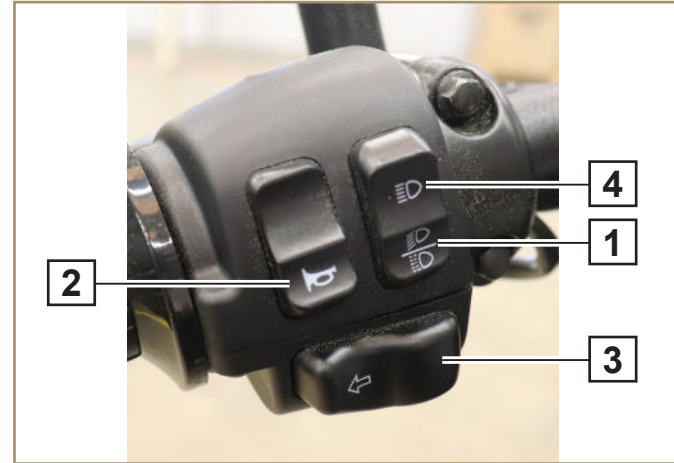

Right hand switch

1. Electric start switch

When the gear is in neutral position, the ignition button can be used to start the engine .



In gear engaged position, withdraw the stand, pull the clutch lever and simultaneously press the ignition button to start the engine.

2. Light switch

2a. The daytime running lights are on;

2b. The low beam is ON and the instrument LED  is lit.

3. Flameout switch

When set to "", the engine is running; the engine shutdown switch is an emergency switch, if necessary, move this switch to the  position.

4. Right turn direction indicator button

- Press the button on the right to activate the right turn indicator lights.
- Press the button on the left to deactivate the indicator lights.

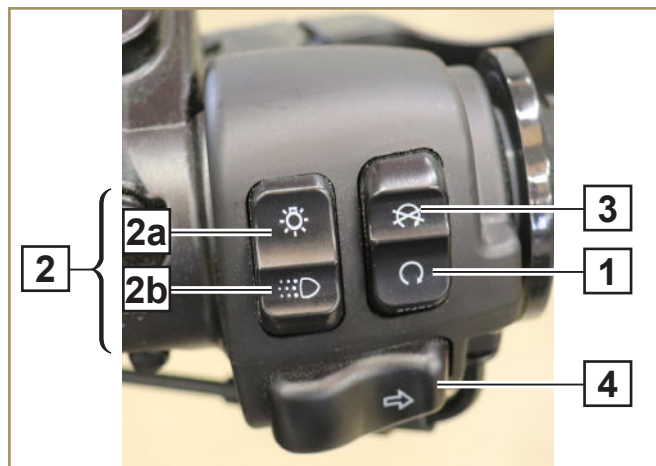

Emergency lights switch

To activate the four direction indicator lights, press buttons (1) and (2) at the same time in the part indicated by the arrow embossed on the button itself.

To deactivate the direction indicator lights, press buttons (1) and (2) from the opposite side.



Clutch lever

Pull the clutch lever (1) towards the handlebars to interrupt transmission from the engine to the clutch (and to the rear wheels).



IMPORTANT

To avoid premature damage to the clutch components, do not pull the clutch lever when the engine is accelerating.



Front Brake lever

Pull the front brake lever (1) towards the handlebar to activate the front brake caliper.



Check of the clutch cable

The clutch lever located on the left hand side of the handlebars is equipped with cable adjustment.

Adjustment of the clutch cable

The clutch cable can be adjusted by increasing or reducing lever travel.

- Loosen the ring nut (1).
- Adjust the effective useful length of the cable by rotating the regulator (2).
- Tighten the ring nut (1).

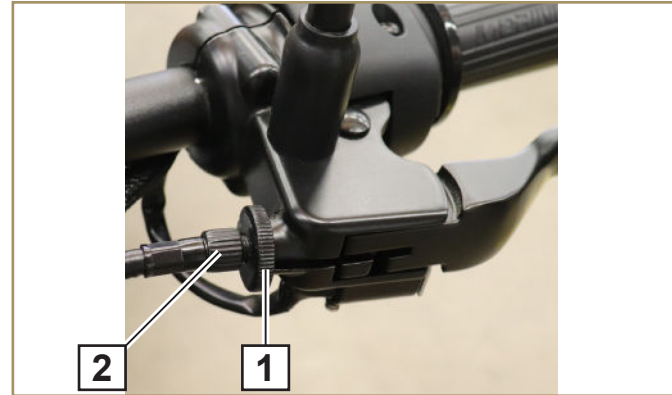

NOTE

Adjust to the best condition of the vehicle according to personal driving habits.

NOTE

Excessive idle travel or no idle travel at all may cause damage to the clutch.

Rear shock absorber

The rear shock absorber is equipped with an external regulator to set the shock absorption parameters according to different load conditions.

NOTE

The factory default setting of the rear shock absorber is calibrated based on a riding weight of 75 kg (position 2).



INTERVENTIONS

Spring preload adjustment

To adjust the spring preload (1), operate on the ring nut (2).

The ring nut (2) has five positions. By turning it towards "A", the preload is increased; turning it towards "B" it decreases.

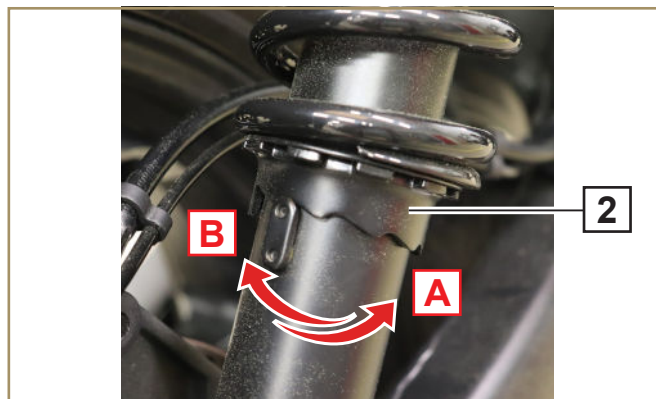
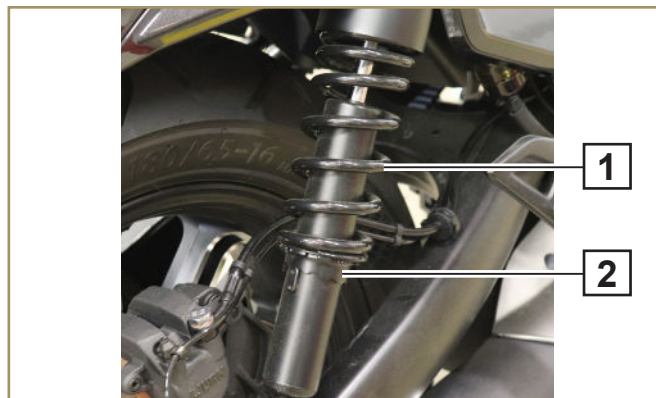

Gear shifting lever

- Every time the shift lever pedal (1) moves up and down corresponding to engaging different gears (one gear at a time).

Start

- a. Make sure that the side stand is in the lifted position;
- b. Pull the clutch handle;
- c. Press the gear lever pedal (1) down to engage the first gear;
- d. Turn the throttle grip gradually to increase the engine revs. and release the clutch lever at the same time.

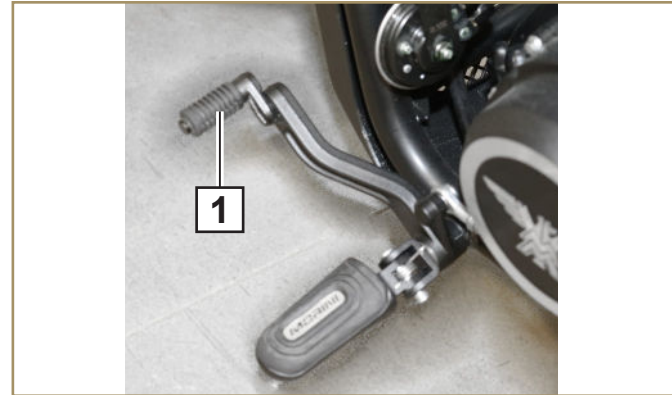

Gear shift

- a. Loosen the throttle handgrip and pull the clutch lever.
- b. Raise or press the gear shifting lever to switch to a higher or lower gear.
- c. Turn the throttle knob and simultaneously release the clutch lever.

Position adjustment

The position of the gear shift pedal can be adjusted to meet the rider's needs.

The adjustment method is as follows:

- Use a wrench to loosen the nut (1) and nut (2);
- work on the adjustment bar (3) to lower or raise the gear shifting lever position based on the respective needs;
- Sit in the main seat to check if it is in the right place.

Tighten nut (1) and nut (2) completely.

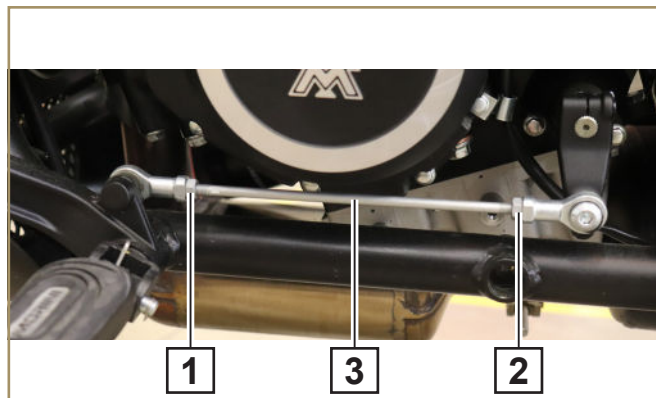

Rear Brake Pedal (1)

The rear brake is engaged by pressing the pedal with the foot.

- Release the throttle grip completely and press the brake pedal to reduce the speed of the motorcycle;
- To brake correctly, use the front brake lever and the rear brake pedal simultaneously;
- When turning, first reduce speed and do not brake suddenly.



Adjust the position of the rear brake pedal

- To adjust the rear brake pedal, loosen the locking nut (2) and turn the regulator (3) until the brake lever reaches the desired position.
- Sit on the seat and check the position.
- Tighten the lock nut (2).
- The rear brake pedal can only lower the height.

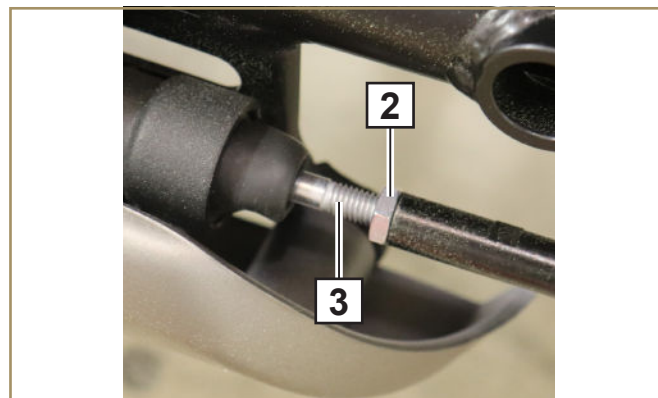

Side Stand



IMPORTANT

Before operating the side stand (1), check compactness and uniformity of the support surface. Lawn, muddy or rugged terrain, softened asphalt and other ground can cause the motorcycle to tip over and cause serious damage;

If it is a steep slope, park the motorcycle with the front wheel facing up;

When lateral inclination or bumps occur, park the side stand on the most possible flatroad;

Regularly check whether the spring return and the safety sensor (2) are working properly;



WARNING!

Do not sit on the seat when parking the vehicle with side stand.

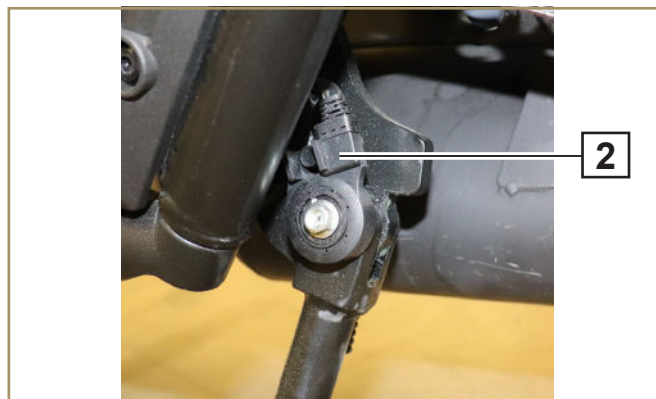

Tires

Type: **Tubeless tire**

- Front: option 1: 130/70 18
 option 2: 130/70 R18

- Rear: option 1: 180/65 16
 option 2: 180/70 R16

	Tire pressure(bar)	
	front	rear
Only driver	2,5	3,0
With passenger	2,5	3,0



NOTE

Check and restore tire pressure with cold tires.



IMPORTANT

In terms of load (that is, the total weight of the motorcycle), sufficient tire pressure is an extremely important factor to ensure safe driving.



IMPORTANT

Check the condition of the tires every time you drive. Whenever there are cuts, cracks, bulges, etc., the tires should be replaced immediately. When the tire tread is worn out, the tire becomes easy to puncture and malfunction; tire tread marks are an important reference for tire replacement.



WARNING!

In order to ensure safe and stable driving, please use the recommended standard tires and rims, and inflate the tires to standard pressure.

Surface warning mark



Fuel Tank

Refueling

- Only after stopping the engine and placing the motorcycle on the side stand can allow to open the fuel tank cap.
- Do not smoke or start the engine when refueling.

Fuel tank	Liters
Total capacity	16
Reserve	4



IMPORTANT

Immediately wipe off the fuel spilled from the fuel tank or other parts of the motorcycle.



Terms of use



WARNING!

- The owner of the motorcycle is personally responsible for maintaining the best condition of the motorcycle.
- Improper maintenance, long-term non usage and exposure to bad weather can cause serious damage and threaten the lifespan and performance of the motorcycle.
- Leaking of fuel tanks or flat tires can cause serious consequences. Therefore, it is very important to thoroughly inspect the motorcycle and its main components before use.
- If the motorcycle is not operating normally, the driver must stop immediately and turn off the engine.
- Contact the affiliated service center and/or road assistance.

Run-in (1000 km)



IMPORTANT

Good running-in is essential to the service life of all moving parts to ensure their long-term normal operation. During the running-in period, it is recommended not to drive with the throttle control lever always in the same position.



WARNING!

Remember to perform the first maintenance after driving 1000 kilometers.

Check items before use

Description	Check
Fuel	Remaining quantity
Engine oil	Optimal liquid level and no leakage
Coolant	Optimal liquid level and no leakage
Tires	Pressure-wear-potential damage
Steering	Free rotation in both directions
Suspension	Adjustment
Brake	Operation-wear-no leakage
Belt	Suitable tension
Throttle control	Please control the throttle gently, without unnecessary operation, lubricate and adjust if necessary.
Lights and indicator lights	Check whether the operation is correct.

Riding skills

- Let the engine idle for a few minutes before riding;
- Do not let the engine idle for a long time;
- Do not start the engine indoors or in a poorly ventilated space. Exhaust gas is extremely toxic;
- Don't accelerate too fast when starting, and don't turn the throttle handle suddenly;
- When turning or changing lanes, always use direction indicators to indicate ,etc.;
- Do not accelerate when the brakes are engaged;
- Under normal road conditions, it is best to use the front brake;
- After travelling a long distance under hot conditions, it is advised to let the engine run at idling speed for a few minutes before switching it off.

Safety precautions for the first use of motorcycles

Until the mileage does not exceed 300 kilometers-in all gears, do not exceed 5500 rpm.



IMPORTANT

It is recommended to change the engine speed frequently without exceeding the specified limit. It is also recommended to check the chain tension and lubrication frequently.



IMPORTANT

To ensure that the friction materials (brake pads and brake discs) run in correctly, excessive and prolonged braking should be avoided. The mileage from 300 kilometers to 500 kilometers 7500 rpm in all gears should not be exceeded.



IMPORTANT

After reaching the first 1000 kilometers, go to a MOTOMORINI authorized service center for the first inspection.

Info before start



IMPORTANT

Before starting the engine for the first time, be familiar with the control operation, because every action must be smooth and without any interference.

**WARNING!**

Never start the engine indoors. Exhaust gas is highly toxic and may cause coma and death.

Start the engine

- As long as the engine is in neutral gear and the clutch lever is pulled, the engine can be started with the side stand down;
- To start the engine when it is in gear, you must pull the clutch lever and retract the side stand;
- Do not turn the throttle handle.

NOTE:

The engine start does not require any manual cold start device. The electronic control unit manages the engine start and automatically determines the most suitable idle speed according to the temperature, humidity, atmospheric pressure and the internal temperature of the engine.

Start

- Turn the key to the "on" position (1);
- Press the start button (2) to start the engine, if the engine fails to start within 5 seconds, please release the start button, press the start button again after 3 seconds, and repeat the above actions.

NOTE

If the engine fails to start within 3 times, please check the battery level.



IMPORTANT

A few seconds after the engine is started, the oil pressure warning light will automatically go out. If the indicator light is still on, immediately turn off the engine and check the oil level. If the oil level is correct, please contact MOTO MORINI Service Center.



**IMPORTANT**

Do not run the engine at an excessively high speed. The oil must gradually heat up in order to reach all parts that need to be lubricated.

**WARNING!**

When the engine is started, the warning light (ABS) is on. If it exceeds 5km/h, the warning light is off.

If the light stays on, stop the engine immediately and restart the motorcycle. If the warning light does not turn off, please contact a Moto Morini Authorized Service Center.

Acceleration

- As already hinted, after starting the engine it is necessary to let it run at idling speed for a few minutes. To start motion, completely pull the clutch lever and firmly push the gear shifting lever to engage the first gear.
- Slowly release the clutch lever, accelerating gradually;
- To switch to the second gear, release the throttle, pull the clutch lever, raise the gear shifting lever with your foot, release the clutch lever and accelerate at the same time. Follow the same process for all the other gears. To shift down the gears, release the throttle command, pull the clutch lever, then engage the lower gear and release the clutch lever.



IMPORTANT

On winding roads, such as mountain roads, when the engine speed decreases, downshifts should be carried out in time according to the vehicle speed.

Deceleration and Braking

- Except for sudden obstacles, the brakes must be used gently to avoid locking the wheels and prevent the motorcycle from losing control.
- Decelerate by shifting gears and using engine brakes, and then adjust the braking force by using two brakes.
- On slippery or bumpy roads, roads with holes, poorly repaired roads, granular debris, etc., it must be adjusted to the corresponding mode. In fact, in this case, the traction will undoubtedly be affected, so the brakes must be used carefully.
- On long and steep slopes, shift gears and rely on the braking ability of the engine. use the brake briefly; continuous use will inevitably cause the friction material to overheat, which will reduce the braking efficiency.

Stop the vehicle

- Release the throttle command to decelerate gradually. Pull the clutch lever, shift down gears and engage neutral gear (position between the 1st and the 2nd gear), then use the brake to stop the motorcycle.



IMPORTANT

When the engine is off, do not leave the key in the vehicle to avoid damage to the electrical components.

Parking the vehicle.

- Put down the side stand of motorcycle;
- Lock the steering lock;
- Do not park the motorcycle near heat sources;
- When parking for a short time in low visibility conditions, please keep the parking light on;
- Do not leave the light on for a long time to avoid draining the battery;
- Do not leave the ignition key in the vehicle, and do not leave the motorcycle unattended, even for a few minutes;
- Do not park the vehicle on dry leaves, plastic materials or wooden surfaces, because the high temperature of the silencer with catalytic may cause fire;
- Do not park your vehicle under a tree. In some seasons, resin residue, fruits or leaves may fall off the tree. These elements may contain chemicals that can damage paint and plastic parts.

General cleaning



IMPORTANT

- Do not wash the motorcycle immediately after use. Water that evaporates in close contact with hot surfaces may cause stains;
- Do not wash the motorcycle under direct sunlight, especially in summer, because the wash liquid may dry out before rinsing, resulting in damage to the paint;
- Avoid high-pressure water or high-pressure air from entering electrical components, vents, edges of exhaust silencers, instrument panels.



IMPORTANT

If the engine parts are very dirty, please use a specific degreasing product. Avoid contact with painted parts, pulleys, brake discs, etc. When cleaning plastic and rubber parts, never use solvents or diluents.

NOTE

In order to maintain the gloss of painted and metal parts, if the motorcycle is used under the following conditions or situations, it should be cleaned regularly: atmospheric pollution, high atmospheric salinity, rain or atmospheric humidity, contact with salt or deicing products used in winter. Pay attention to whether there are industrial powder residues, tar stains, dead insects, etc. on the motorcycle body.

To remove dirt on painted parts, use a low-pressure water jet to moisten thoroughly, and remove dirt with the help of a soft sponge and vehicle wash liquid. Always use high-quality organic products and avoid harsh cleaners and solvents. Rinse with clean warm water and carefully dry all surfaces with a deerskin cloth.



WARNING!

After cleaning, the brake may not work properly. Because there is water on the friction surface of the brake system, it may temporarily affect the braking, and the brake disc must be cleaned with a special cleaning agent for motorcycles.

Long-term parking

Before storing the motorcycle for a long time, such as in winter, do the following:

- General cleaning
- Raise the motorcycle so that the tires can be lifted from the ground and deflate.
- Remove the battery, the battery must be charged periodically (check and recharge every month).

Cover the motorcycle with a suitable cover to protect the vehicle paint and prevent moisture.

Maintenance

In order to keep the motorcycle in good running condition, regular maintenance must be carried out in accordance with the maintenance chart;

1. Periodic inspection

Periodic checks	period every ↓	* Total mileage display Km/miles						
		Whichever comes first →						
		1000 600	6000 3700	12000 7400	18000 11100	24000 14800	30000 18500	36000 22200
Check and cleaning of the air filter				●		●		●
Valve clearance-check	42000 km 25900 mi							
Throttle system (clearance, flexible return)-check	1year	●		●		●		●
Idle speed-check		●		●		●		●
Fuel leak (fuel pipe)-check	1year	●		●		●		●
Fuel pipe damage-check	1year	●		●		●		●
Fuel pipe installation-check	1year	●		●		●		●
Check and/or cleaning of the throttle body			●	●	●	●	●	●
Coolant level check		●		●		●		●
Coolant leak-check.	1year	●		●		●		●

Damage to radiator and pipeline-check.	1year	●		●		●		●
Radiator and pipeline installation-check.	1year	●		●		●		●
Intake system damage-check				●		●		●
Clutch and drive belt								
Clutch operation (clearance, engagement, disengagement)-check		●		●		●		●
Inspect the drive belt	600 km 371 mi							
Check drive belt tension	3000 km 1800 mi	every 5000 km every 3106 mi						
Verify drive belt wear				●		●		●
Check the status of wear of the drive belt guard				●		●		●
Rim and tire, wheels bearings								
Tire pressure-check		●		●		●		●
Rim/tire damage-check				●		●		●
Tire surface wear and abnormal wear-check				●		●		●
Wheel bearing damages check				●		●		●
Check pinion housing bearings				●		●		●

Braking System								
Brake pedal pin lubrication		●		●		●		●
Brake fluid leakage-check	1year	●	●	●	●	●	●	●
Damage to the brake fluid pipe-check	1year	●	●	●	●	●	●	●
Brake pad wear-inspection			●	●	●	●	●	●
Brake fluid pipeline installation-check	1year	●	●	●	●	●	●	●
Brakes fluid level check	6 months	●	●	●	●	●	●	●
Brake control (braking force, clearance, flexible action)-check	1year	●	●	●	●	●	●	●
Brake light switch operation-check		●	●	●	●	●	●	●
Suspensions								
Front fork/rear shock absorption (smooth cushioning)-check				●		●		●
Front fork/rear shock absorber hydraulic oil leakage-check	1year			●		●		●
Control system								
Steering clearance-check	1year	●		●		●		●
Steering Bearing-Lubrication	2 years					●		

Electrical system								
Light and switch operation-check	1year			●		●		●
Headlight-check	1year			●		●		●
Engine start-up switch check	1year			●		●		●
Engine switch-off switch operation check	1year			●		●		●
Chassis								
Chassis Parts-Lubrication				●		●		●
Check for tightening of studs and nuts and torque values		●		●		●		●

2. Regular replacement

Regular replacement items	period every ↓	* Total mileage display Km/miles				
		Whichever comes first →				
		1000 600	12000 7400	24000 14800	36000 22200	48000 29600
Air filter element	2 years		●	●	●	●
Engine oil	6 months	Every 5000 km / first 1000 km				
Oil filter	6 months	Every 5000 km				
Fuel pipe	4 years					●
Coolant	2 years				●	
Radiator, pipeline	2 years				●	
Brake fluid line	4 years					●
Brake fluid (front/rear)	2 years			●		●
Brake pump rubber seal	4 years					●
Spark plug			●	●	●	●

Daily maintenance

These maintenance tasks must be considered and must be strictly performed by the owner; the long life and performance of the motorcycle depend to a large extent on these operations.

NOTE

Routine maintenance operations are usually carried out by the owner, but often require sufficient technical training and specific tools; if in doubt, it is recommended to contact the MOTOMORINI authorized service center, which will provide safe and competent services.

Before starting any maintenance work or inspection, place the motorcycle on a flat, solid ground in a well-ventilated protective space, and check whether the engine and exhaust system are sufficiently cooled to avoid spontaneous combustion.



INTERVENTIONS

The maintenance operations marked with this symbol are the exclusive rights of authorized personnel and must be done in the MOTOMORINI authorized service center;

If these rules are not followed, the manufacturer will waive all responsibilities and claims and will invalidate the warranty (if it has not expired), as this is considered a "vehicle modification". MOTOMORINI also does not encourage you to perform these operations yourself, because they may cause serious damage or death.

Engine oil

First replacement after 1000 km and then every 5000 km.

- The oil level must be checked for cold or warm engines; if the engine is overheated, wait a few minutes for the oil to stabilize in the oil sump.

Keep the motorcycle perpendicular to the ground.

- The liquid level can be checked from the view glass and is correct when it is in the middle of the window (1).
- If the level of oil is lower than the central line of the indicator, top it up from the top filling cap (2).
- Oil: 10W40-SN grade fully synthetic motor oil 

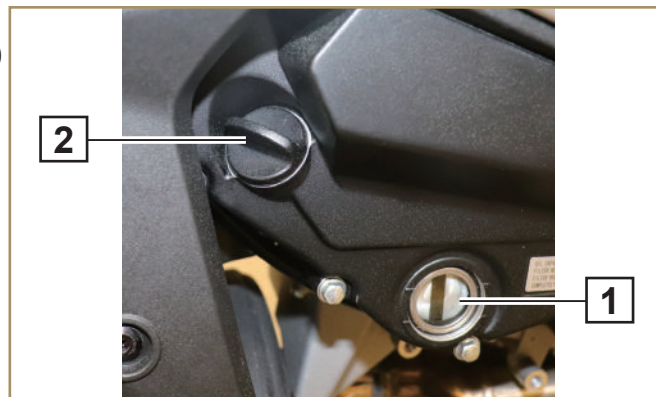

NOTE

Check the oil level before a long trip.

NOTE

If you use a funnel or similar tool when filling engine oil, please check whether it is clean; foreign matter or water entering the engine may cause serious damage.

- After topping up, remount the filling cap, start the engine and let it run at idling speed for a few minutes, then check that there is no oil leakage and that the indicator on the dashboard switches off after a few seconds. If that does not happen, stop the engine and perform the necessary checks.
- About three minutes after turning off the engine, check the oil level again.

**WARNING!**

Do not mix different incompatible oils to avoid damage to the engine. If there is no recommended engine oil, please use a compatible engine oil. The oil compatibility can usually be checked on a specific chart at a gas station or specialty store.

MOTOMORINI is not responsible for any damage caused by the use of oil with different characteristics from the recommended oil.

Brake fluid

Brake fluid DOT 4.0 



IMPORTANT

Under normal braking conditions, check every 10,000km

Brakes are the most important component to ensure driving safety, and they must always be in perfect condition. Both wheels of the motorcycle are equipped with hydraulic disc brakes.



WARNING!

Brake fluid and clutch fluid are extremely corrosive and may cause serious injury to the owner and damage the motorcycle. The liquid level must always be higher than the "min" indicator displayed on the two liquid storage tanks. Too low brake fluid level may result in low efficiency of the braking system.



IMPORTANT

Be sure to use the recommended liquid taken from an unopened container. Be careful not to let foreign objects, water, etc. enter together with the liquid. If the oil brand needs or must be changed, the entire system must be drained. This operation can only be performed by authorized personnel.

Never mix different and possibly incompatible liquids.

Liquid level check

(Brake fluid)

Lean the motorcycle to let the liquid be placed horizontally.

- **Front brake:** Check the fluid level inside the oil tank of the front brake through the inspection glass (1). Check that the level of brake fluid in the oil tank is half-way on the inspection window (1) in correspondence with the "LOWER" line.
- **Rear brake:** Check that the brake fluid level inside the oil tank (2) of the rear brake is between the "MAX" and "MIN" levels (3).



WARNING!

If the brake fluid decreases, do not use the motorcycle, do not fill up the brake fluid, and immediately contact the Moto Morini Authorized Service Center.

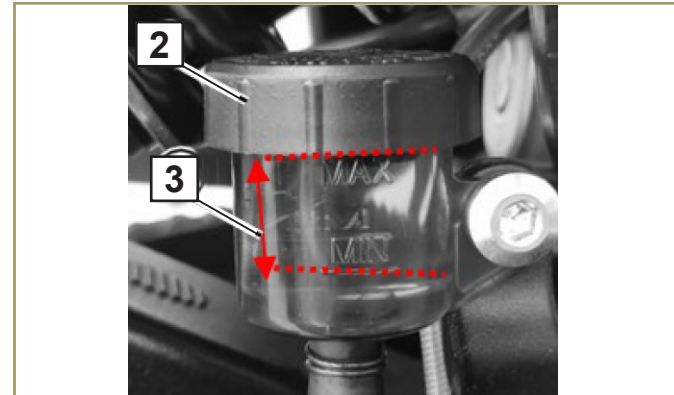

Coolant

- The coolant liquid expansion tank (1) is on the right side of the motorcycle, behind the radiator.

Liquid level check:

- Check the level of coolant inside the expansion tank with the engine and the motorcycle perpendicular to the ground.

NOTE

Engine must be cold.

- The correct level of the liquid is between the indicators (F) and (L), visible on the outer surface of the tank on the right side of the motorcycle.
- The cover (2) must be removed for any liquid filling.



Coolant type: **GLYSANT G40** 

**WARNING!**

Except in the case of clear emergency, do not add fluid.

NOTE

If the coolant temperature is too high, the fan is automatically operated and it's protected by a fuse.

**WARNING!**

If the coolant consumption is irregular or the cooling system leaks, please do not use the motorcycle and contact a MOTOMORINI authorized service center.



Brake pads

Wear check

Inspection: every 5000km



IMPORTANT

Used on dusty roads, wet roads, winding roads or mountain roads, the brake pads of motorcycles need more frequent wear inspections.

- It is not necessary to remove the brake pads when performing the inspection.
- There are indicating grooves on the friction material of the front brake pads to determine whether to replace the brake pads;
- When the brake pads are still in good condition, the grooves can be seen.

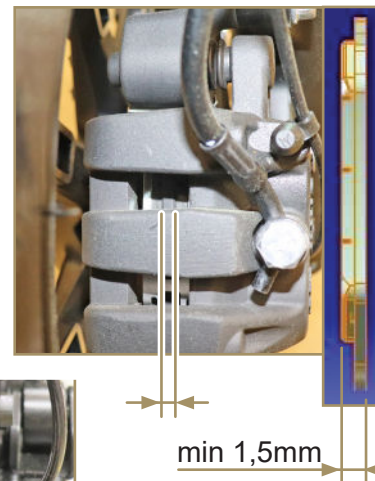
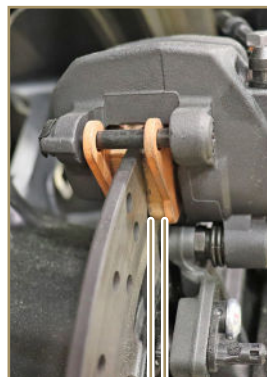

INTERVENTIONS

The minimum thickness of the brake pad friction material is 1,5 mm. If one brake pad is excessively worn, both brake pads must be replaced at the same time, and the original brake pads must be used.

Drive belt

NOTE

The tension of the drive belt must be checked frequently.

- Switch the vehicle off and park on flat land.
- Use the relevant instrument or the Gates® Carbon Drive™ application (available for Android and Apple) to check the tension of the belt.
- Pinch the belt in the point (1) shown in the figure and measure the frequency.
- Take several measurements to ensure that the measurement is consistent.
- Turn the rear wheel by 90° and repeat the procedure.
- The belt tensioning values are equal to 56-63 Hz in the case of a new belt and 45-50 Hz after the first 3000 km of vehicle use.

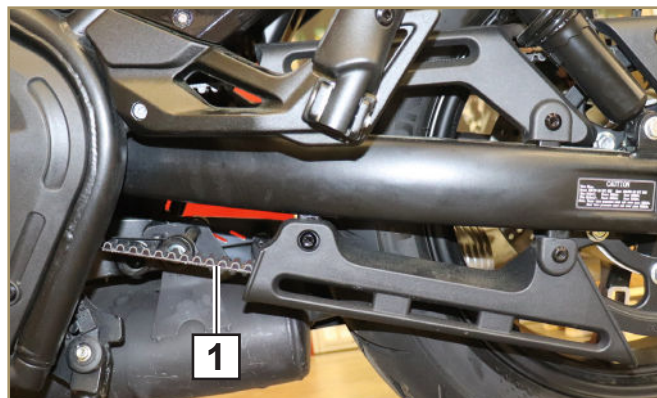

WARNING!

Unsuitable belt tension can lead to premature wear of the drive components and faults.

Electrical components

Fuses

- Remove the rider's saddle as described in the relative paragraph;
- Loosen the screws (1) and remove the guard (2);
- The fuses are positioned in two different boxes (3) and (4), lift the respective lids to access them;
- Before replacing the fuse, try to solve the problem that caused the fuse to "burn out";
- Find and remove the blown fuse, and then replace it with a fuse of the same rating.

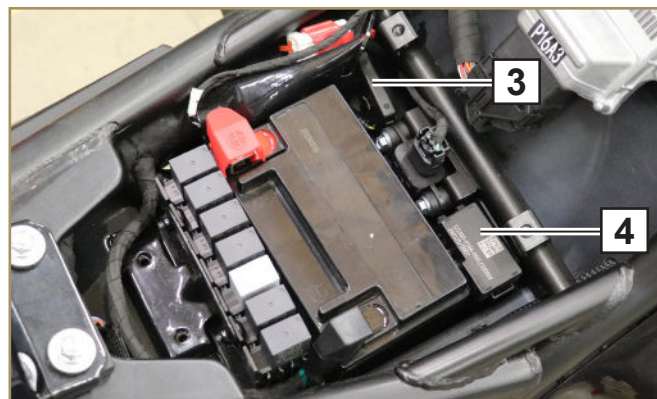
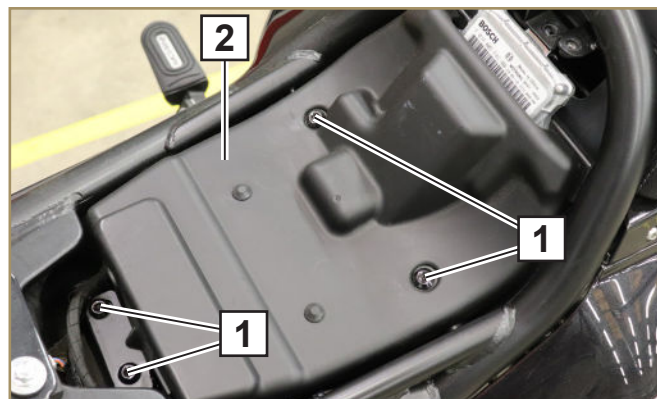

WARNING!

When replacing the fuse, be sure to use a fuse of the same rating, because it may seriously damage the electrical system and cause a fire due to a short circuit.

No.	Ah	Functions
1	30	Engine fuse
2	15	Headlamp and signal system
3	5	ECU
4	10	Lambda sensor heating
5	15	Fuel pump relay, main relay
6	15	Fan relay/start auxiliary relay
7	7,5	ECU
8	15	Spare fuse
9	10	Spare fuse
10	7,5	Spare fuse
11	5	Spare fuse
12	10	ABS system
13	15	ABS system

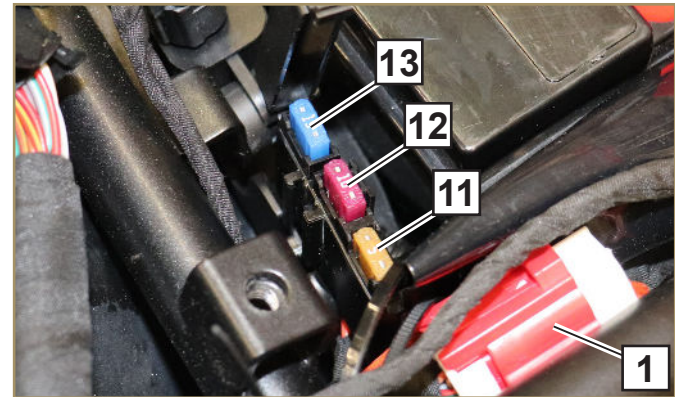
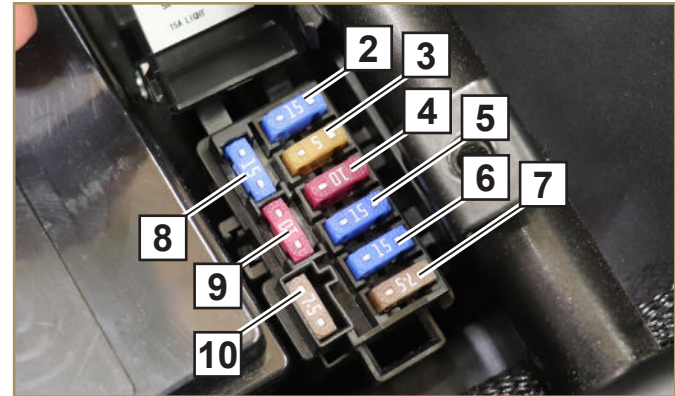

Ignition coils diagnostics sockets

The diagnostics sockets (1) and (2) of the two coils are positioned under the rider's saddle, near to the battery and are to be used exclusively by MOTO MORINI technicians.



IMPORTANT

The caps (3) that contain the resistor must be removed by the user to avoid compromising normal use of the vehicle.

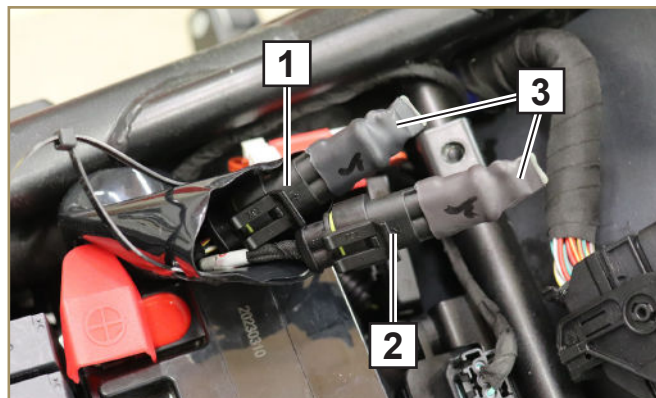

Battery

The battery installed on the motorcycle is a wet maintenance-free type, so there is no need to check the battery electrolyte level or add distilled water.

The battery has been fully charged in the factory, the users must check that the voltage is between 12.6V~13.15V before assembling it; if the voltage is within this range it can be assembled on the motorcycle, if the voltage is below the range indicated, the battery must be charged before assembling it.

NOTE

Do not remove the sealing strip, otherwise the battery will be damaged. Do not install traditional batteries on the motorcycle, otherwise the electrical system will not work properly.

Battery Maintenance

It is the owner's responsibility to maintain sufficient power in the motorcycle battery.

Otherwise, it may cause the battery to lose power and cause the motorcycle to break down.

If your motorcycle is not used for a long time, you should use an appropriate charger to charge the battery or remove the vehicle battery.



WARNING!

Do not charge or place the battery near a heat source or open flame; keep out of the reach of children. The battery can only be charged with a dedicated charger, which can be charged in your motorcycle dealership store.

Remove the battery

- Make sure the ignition switch is turned off
- For information regarding removal of the rider's saddle, consult the "Removal and re-assembly of the rider's saddle" section.
- Disconnect the battery cable, first disconnect the negative (-) terminal, then the positive (+) terminal
- Loosen the screws that secure the cables to the battery terminals.
- Remove the battery.



WARNING!

Do not open the battery, do not add distilled water or electrolyte.

Re-Install the battery

- Position the battery in its respective seat.
- Connect the positive (+) cable to the positive (+) terminal, and then connect the negative (-) cable to the negative (-) terminal.
- Tighten the screws that fix the cable to the battery terminals.
- Cover the positive (+) terminal with red insulation.



WARNING!

Connecting the negative wire to the positive terminal of the battery or connecting the positive wire to the negative terminal of the battery will cause serious damage to the electrical system.



IMPORTANT

Pay attention to the location of the terminals and the polarity of the cable.

Red = positive (+)

Black = negative (-)

Headlamp



INTERVENTIONS

Regularly check the beam pattern of the headlights at MOTO MORINI authorized service centers or trusted service centers.

- Adjusting the lights up and down by directly rotating the inner screw under (1) the headlight.
- Adjust the light beam as indicated in the figure.
- Daytime light/front parking light: 3,8/0,3 W.
- Low beam/high beam: LED-14/30W.

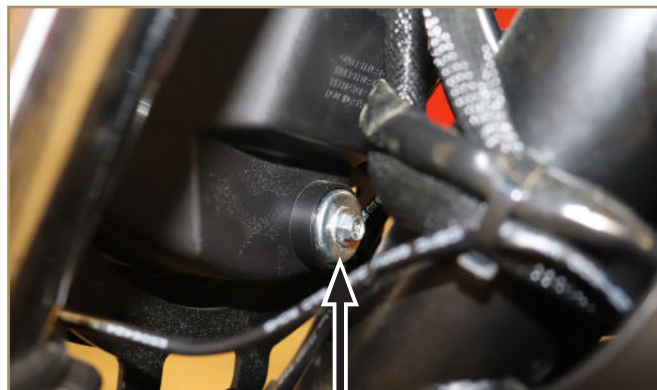

Adjustment device (1)

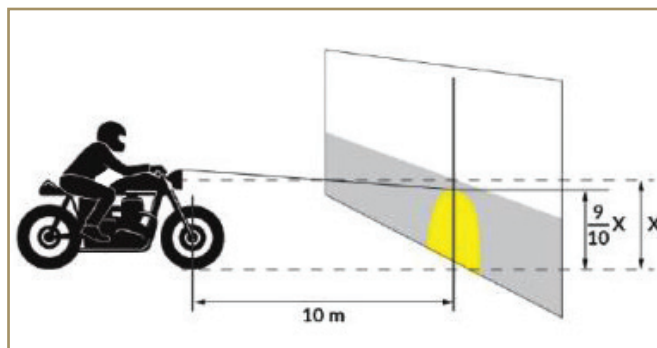

Indicator lights

The direction indicator uses a set of non-replaceable LEDs. If the indicator does not work, the entire indicator must be replaced at a MOTOMORINI authorized service center.

License plate light

The license plate light uses a set of non-replaceable LEDs. If the light does not work, the whole lamp body must be replaced at a MOTO MORINI's authorized assistance centre.

Tail light

The tail light uses a series of LEDs that cannot be replaced. If the light does not work, it must be replaced at a MOTO MORINI's authorized assistance centre.

MOTOMORINI®



ITALIA DAL 1937