



Parts No.	Description	Qty per Vehicel
PMZ150-1-A-001Metallic Red	Upper Panel of Front Right	1
PMZ150-1-A-001Moss Green	Upper Panel of Front Right	1
PMZ150-1-A-001Metallic Tan	Upper Panel of Front Right	1
PMZ150-1-A-001Metallic Yellow	Upper Panel of Front Right	1
PMZ150-1-A-001Brown	Upper Panel of Front Right	1
PMZ150-1-A-002	Lower Panel of Front Right	1
PMZ150-1-A-003	Connect plate of front mask	1
PMZ150-1-A-004	Headlight Decorating plate	1
PMZ150-1-A-005	Headlight	1
PMZ150-1-A-006	Front Mask	1
PMZ150-1-A-007	Front Bracket	1
PMZ150-1-A-008Metallic Red	Upper Panel of Front Left	1
PMZ150-1-A-008Moss Green	Upper Panel of Front Left	1
PMZ150-1-A-008Metallic Tan	Upper Panel of Front Left	1
PMZ150-1-A-008Metallic Yellow	Upper Panel of Front Left	1
PMZ150-1-A-008Brown	Upper Panel of Front Left	1
PMZ150-1-A-009	Lower Panel of Front Left	1
PMZ150-1-A-010	Left guard of Mask	1
PMZ150-1-A-011	Right guard of Mask	1
PMZ150-1-A-012	License holder rubber	2
PMZ150-1-A-013	Windshield holder	1
PMZ150-1-A-014	Winshield	1



Parts No.	Description	Qty per Vehicel
PMZ150-1-B-001	Rear fender bracket upper	1
PMZ150-1-B-002	Rear Reflector	1
PMZ150-1-B-003	Side Reflector	2
PMZ150-1-B-004	Rear Wheel Fender	1
PMZ150-1-B-005	Rear fender bracket down	1
PMZ150-1-B-006	Rear Left turning light	1
PMZ150-1-B-007	License Light	1
PMZ150-1-B-008	Rear Fender	1
PMZ150-1-B-009	Rear Cover	1
PMZ150-1-B-010	Front Part of Rear Fender	1
PMZ150-1-B-011	Tail light	1
PMZ150-1-B-012	License Light Bracket	1

PMZ150-1-B-013	Rear Wheel Fender Bracket	1
PMZ150-1-B-014	Rear Right turning light	1
PMZ150-1-B-015	Rear Reflector Left Bracket	1
PMZ150-1-B-016	Rear Reflector Right Bracket	1

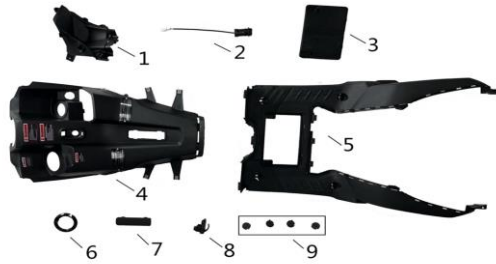

Parts No.	Description	Qty per Vehicel
PMZ150-1-C-001	Inner Cover of Luggage	1
PMZ150-1-C-002	USB	1SET
PMZ150-1-C-003	Battery cover	1
PMZ150-1-C-004	Gloves box	1
PMZ150-1-C-005	Floor mat	1
PMZ150-1-C-006	Gloves box decorating	1
PMZ150-1-C-007	Vin cover	1
PMZ150-1-C-008	Helmet Hook	1
PMZ150-1-C-009	Floor mat decorating	4

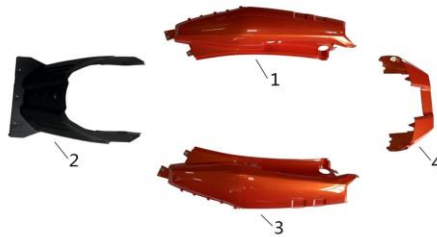

Parts No.	Description	Qty per Vehicel
PMZ150-1-D-001Metallic Red	Right Panel	1
PMZ150-1-D-001Moss Green	Right Panel	1
PMZ150-1-D-001Metallic Tan	Right Panel	1
PMZ150-1-D-001Metallic Yellow	Right Panel	1
PMZ150-1-D-001Brown	Right Panel	1
PMZ150-1-D-002	Luggage front cover	1
PMZ150-1-D-003Metallic Red	Left Panel	1
PMZ150-1-D-003Moss Green	Left Panel	1
PMZ150-1-D-003Metallic Tan	Left Panel	1
PMZ150-1-D-003Metallic Yellow	Left Panel	1
PMZ150-1-D-003Brown	Left Panel	1
PMZ150-1-D-004Metallic Red	Rear Fender upper part	1
PMZ150-1-D-004Moss Green	Rear Fender upper part	1
PMZ150-1-D-004Metallic Tan	Rear Fender upper part	1
PMZ150-1-D-004Metallic Yellow	Rear Fender upper part	1
PMZ150-1-D-004Brown	Rear Fender upper part	1
PMZ150-1-D-005Metallic Red	body kit	1 set
PMZ150-1-D-005Moss Green	body kit	1 set
PMZ150-1-D-005Metallic Tan	body kit	1 set
PMZ150-1-D-005Metallic Yellow	body kit	1 set
PMZ150-1-D-005Brown	body kit	1 set



Parts No.	Description	Qty per Vehicle
PMZ150-1-E-001	Rear Carrier	1
PMZ150-1-E-002	Seat	1
PMZ150-1-E-003	Seat Lock	1
PMZ150-1-E-004	Under seat Storage Bucket	1
PMZ150-1-E-005	Storage Bucket cover	1



Parts No.	Description	Qty per Vehicle
PMZ150-1-F-001	Speed counter	1
PMZ150-1-F-002	Front inner cover connect plate	1
PMZ150-1-F-003	Brake hose clip	1SET
PMZ150-1-F-004	Brake hose clip	1
PMZ150-1-F-005	Front wheel fender	1
PMZ150-1-F-006	Rear Shock	1Pair
PMZ150-1-F-007	Front Shock	1Pair
PMZ150-1-F-008	Triple tree	1
PMZ150-1-F-009	Upper bearing	3
PMZ150-1-F-010	Bottom Bearing	3
PMZ150-1-F-011	Lock Nut	1
PMZ150-1-F-012	Anti-Dust bearing	1
PMZ150-1-F-013	Side Reflector	2
PMZ150-1-F-014	Front Shock panel rubber	4
PMZ150-1-F-015	Left Front shock panel	1
PMZ150-1-F-016	Right Front shock panel	1

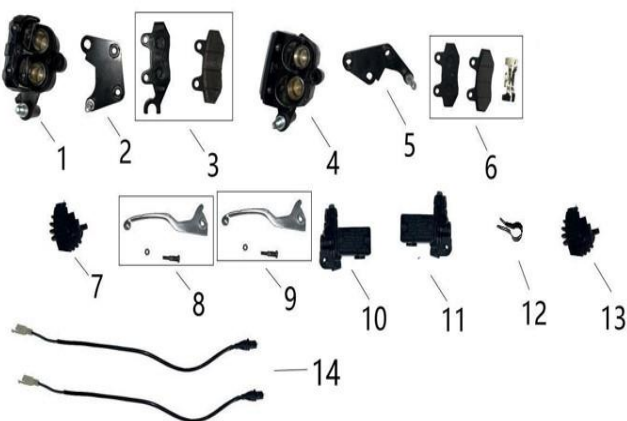

Parts No.	Description	Qty per Vehicel
PMZ150-1-G-001	Rear brake caliper	1
PMZ150-1-G-002	Pump Bracket (caliper mounting bracket) (sold as assembly)	1
PMZ150-1-G-003	Rear Brake pads	1
PMZ150-1-G-004	Front brake caliper	1
PMZ150-1-G-005	Pump Bracket (caliper mounting bracket) (sold as assembly)	1
PMZ150-1-G-006	Front Brake pads	1
PMZ150-1-G-007	Pump Guard (sold with lever)	1
PMZ150-1-G-008	Left Brake Lever	1
PMZ150-1-G-009	Right Brake Lever	1
PMZ150-1-G-010	Rear Brake master cylinder	1
PMZ150-1-G-011	Front Brake master cylinder	1
PMZ150-1-G-012	Brake Hose Clamp	1
PMZ150-1-G-013	Pump Guard (sold with lever)	1
PMZ150-1-G-014	Brake Switch	1

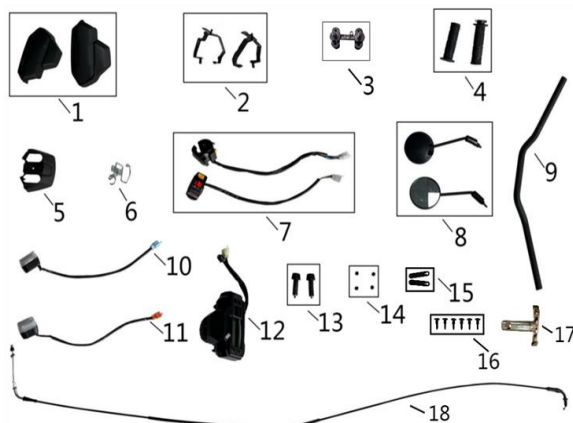

Parts No.	Description	Qty per Vehicel
PMZ150-1-H-001	L hand guard	1
PMZ150-1-H-001-01	R hand guard	1
PMZ150-1-H-002	L Turning light Bracket	1
PMZ150-1-H-002-01	R Turning light Bracket	1
PMZ150-1-H-003	Steering bar clamp	1SET
PMZ150-1-H-004	L Grip	1
PMZ150-1-H-004-01	R Grip	1
PMZ150-1-H-005	Handle bar cover	1
PMZ150-1-H-006	Cable Bracket	1
PMZ150-1-H-007	Right Switch Assy	1
PMZ150-1-H-007-01	Left Switch Assy	1

PMZ150-1-H-008	Right Rear Mirror	1
PMZ150-1-H-008-01	Left Rear Mirror	1
PMZ150-1-H-009	Handle Bar	1
PMZ150-1-H-010	Front Right Turing Light	1
PMZ150-1-H-011	Front Left Turing Light	1
PMZ150-1-H-012	Speedometer	1
PMZ150-1-H-013	Balance Weight	1Pair
PMZ150-1-H-014	Grip Plug	4
PMZ150-1-H-015	Band	2
PMZ150-1-H-016	Screws	6
PMZ150-1-H-017	Handlebar lock holder	1
PMZ150-1-H-018	Throttle Cable	1



Parts No.	Description	Qty per Vehicel
PMZ150-1-I-001	Tyre	1
PMZ150-1-I-002	Rim	1
PMZ150-1-I-003	Brake Disc	1
PMZ150-1-I-004	Sensor disc	1
PMZ150-1-I-005	Collar	1 set
PMZ150-1-I-006	Axle	1
PMZ150-1-I-007	Valve	1



Parts No.	Description	Qty per Vehicel
PMZ150-1-J-001	Tire	1
PMZ150-1-J-002	Rim	1
PMZ150-1-J-003	Brake Disc	1
PMZ150-1-J-004	Valve	1

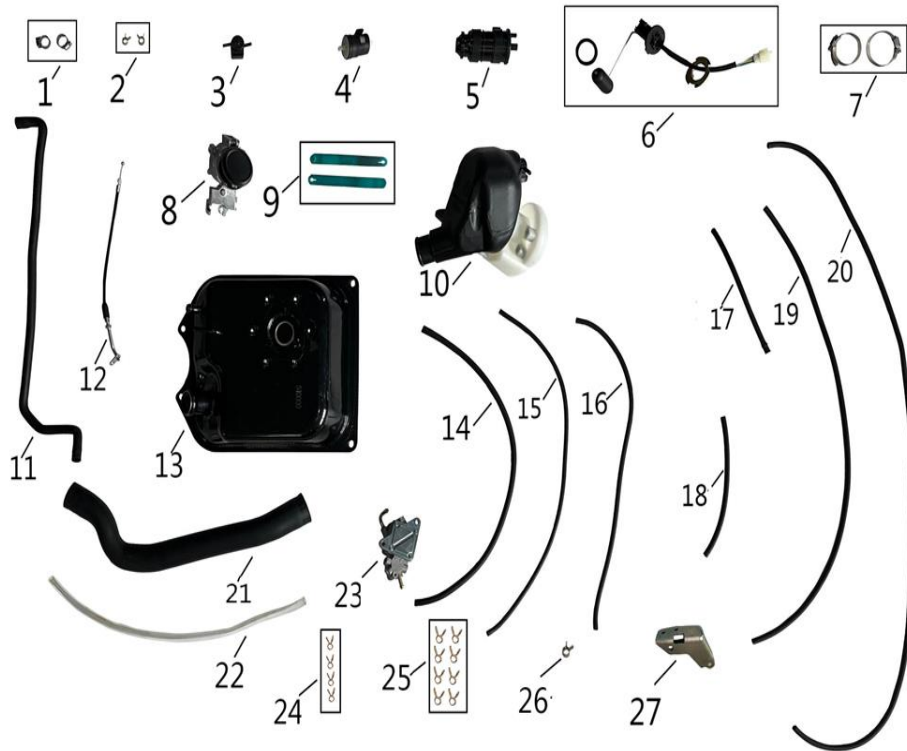

Parts No.	Description	Qty per Vehicel
PMZ150-1-K-001	Clip	2
PMZ150-1-K-002	Clamp	2
PMZ150-1-K-003	Anti-leaking Valve	1
PMZ150-1-K-004	Filter	1
PMZ150-1-K-005	Carbon filter	1
PMZ150-1-K-006	Fuel sensor	1
PMZ150-1-K-007	Clamp	2
PMZ150-1-K-008	Fuel Tank cap	1
PMZ150-1-K-009	Band	1
PMZ150-1-K-010	Oil Tank	1
PMZ150-1-K-011	Fuel Hose	1
PMZ150-1-K-012	Fuel cap lock cable	1
PMZ150-1-K-013	Fuel Tank	1
PMZ150-1-K-014	Fuel Hose	1
PMZ150-1-K-015	Air hose	1
PMZ150-1-K-016	Fuel Hose	1
PMZ150-1-K-017	Air hose	1
PMZ150-1-K-018	Fuel Hose	1
PMZ150-1-K-019	Fuel Hose	1
PMZ150-1-K-020	Air hose	1
PMZ150-1-K-021	Fuel Hose	1
PMZ150-1-K-022	Fuel Hose	1
PMZ150-1-K-023	Fuel Pump	1
PMZ150-1-K-024	Fuel Hose Clamp	1
PMZ150-1-K-025	Clamp	4
PMZ150-1-K-026	Clamp	8
PMZ150-1-K-027	Clamp	2
PMZ150-1-K-028	Fuel Tank bracket	1



Parts No.	Description	Qty per Vehicel
PMZ150-1-L-001	hose bracket	
PMZ150-1-L-002	Fan Cover	1
PMZ150-1-L-003	Carburetor	1
PMZ150-1-L-004	filter	1
PMZ150-1-L-005	Air filter	1
PMZ150-1-L-006	Airfilter cover	1
PMZ150-1-L-007	Airfilter decorating	1
PMZ150-1-L-008	Engine	1
PMZ150-1-L-009	fuel drain hose bracket	1



Parts No.	Description	Qty per Vehicel
PMZ150-1-M-001	Muffler Cover	1
PMZ150-1-M-002	Muffler heat shield	1
PMZ150-1-M-003	Muffler	1
PMZ150-1-M-004	Muffler Gasket	1



Parts No.	Description	Qty per Vehicel
PMZ150-1-N-001	Side stand	1
PMZ150-1-N-002	Main Stand	1
PMZ150-1-N-003	Side Stand Spring	1SET
PMZ150-1-N-004	Main Stand Spring	1
PMZ150-1-N-005	Main stand Rubber Cushion	1SET



Parts No.	Description	Qty per Vehicel
PMZ150-1-O-001	Battery	1

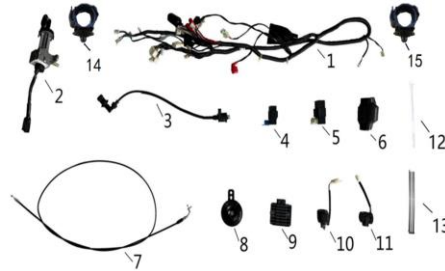

Parts No.	Description	Qty per Vehicel
PMZ150-1-P-001	Wire harness	1
PMZ150-1-P-002	Ignition Lock	1
PMZ150-1-P-003	Ignition Coil	1
PMZ150-1-P-004	Headlight regulator	1
PMZ150-1-P-005	CDI	1
PMZ150-1-P-006	Wire harness Clip	1
PMZ150-1-P-007	Lock cable	1
PMZ150-1-P-008	Horn	1
PMZ150-1-P-009	Regulator	1
PMZ150-1-P-010	Relay	1
PMZ150-1-P-011	Flasher	1
PMZ150-1-P-012	Band	5
PMZ150-1-P-013	Band	5
PMZ150-1-P-014	Cable Clip	1
PMZ150-1-P-015	Cable Clip	2

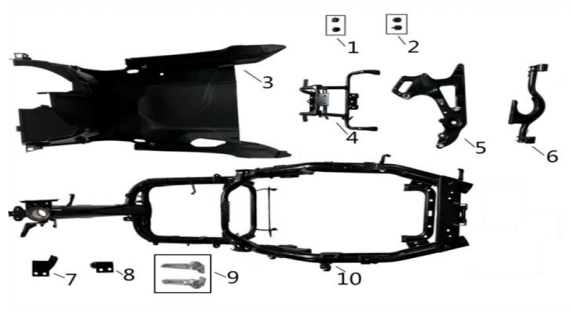

Parts No.	Description	Qty per Vehicel
PMZ150-1-Q-001	Engine hanger rubber plug	2
PMZ150-1-Q-002	Engine hanger rubber cushion	2
PMZ150-1-Q-003	Frame bottom panel	1
PMZ150-1-Q-004	Front Mask Bracket	1
PMZ150-1-Q-005	Muffler Mounted	1
PMZ150-1-Q-006	Engine Hanger	1
PMZ150-1-Q-007	Tail cover Left bracket	1
PMZ150-1-Q-008	Tail cover Right bracket	1
PMZ150-1-Q-009	Left foot rest	1
PMZ150-1-Q-009-01	Right foot rest	1
PMZ150-1-Q-010	Frame	1

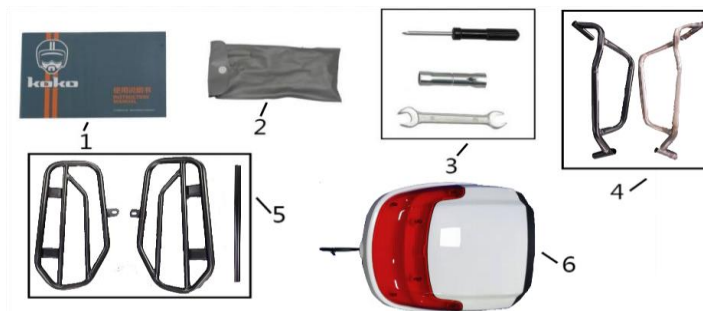

Parts No.	Description	Qty per Vehicel
PMZ150-1-R-001	Manual	1
PMZ150-1-R-002	Tools bag	1
PMZ150-1-R-003	Spark Plug tools	1
	Wrench	1
	Screw driver	1
PMZ150-1-R-004	Front Bumper(Optional)	2
PMZ150-1-R-005	Side Bumper(Optional)	3
PMZ150-1-R-006	Rear Box (Optional)	1